

Owner's Manual

Protect It![®] 3-Outlet Surge Protector with USB Charging

With Desk Clamp: TLP310USBC

With Mounting Brackets: TLP310USBS

| | | | |
|------------------------------------|---|---------------------------|---|
| Important Safety Instructions | 2 | Product Registration | 4 |
| Installation | 2 | Lifetime Limited Warranty | 4 |
| TLP310USBC Desk Clamp Model | 2 | Ultimate Lifetime | 4 |
| TLP310USBS Mounting Brackets Model | 3 | Insurance Policy | |

PROTECT YOUR INVESTMENT!

Register your product for quicker service
and ultimate peace of mind.

You could also win an
ISOBAR6ULTRA surge protector—
a \$100 value!

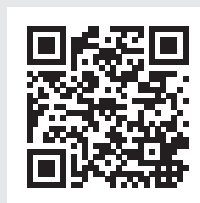

www.tripplite.com/warranty



1111 W. 35th Street, Chicago, IL 60609 USA • www.tripplite.com/support

Copyright © 2016 Tripp Lite. All rights reserved. Protect It![®] is a registered trademark of Tripp Lite.

Important Safety Instructions

SAVE THESE INSTRUCTIONS

CAUTION! DO NOT connect to an ungrounded outlet. DO NOT use with 2-wire extension cords or adapters. This surge protector is designed for indoor use only. Install the surge protector away from heat-emitting appliances such as radiators or heat registers. Do not install where excessive moisture is present. Do not plug extension cords into it. Never install electrical, telephone, network or coaxial wiring during a lightning storm. Do not drill into any part of the housing or open the housing for any reason. There are no user-serviceable parts inside.

- Use of this equipment in life support applications where failure of this equipment can reasonably be expected to cause the failure of the life support equipment or to significantly affect its safety or effectiveness is not recommended. Do not use this equipment in the presence of a flammable anesthetic mixture with air, oxygen or nitrous oxide.

Installation –TLP310USBC Desk Clamp Model

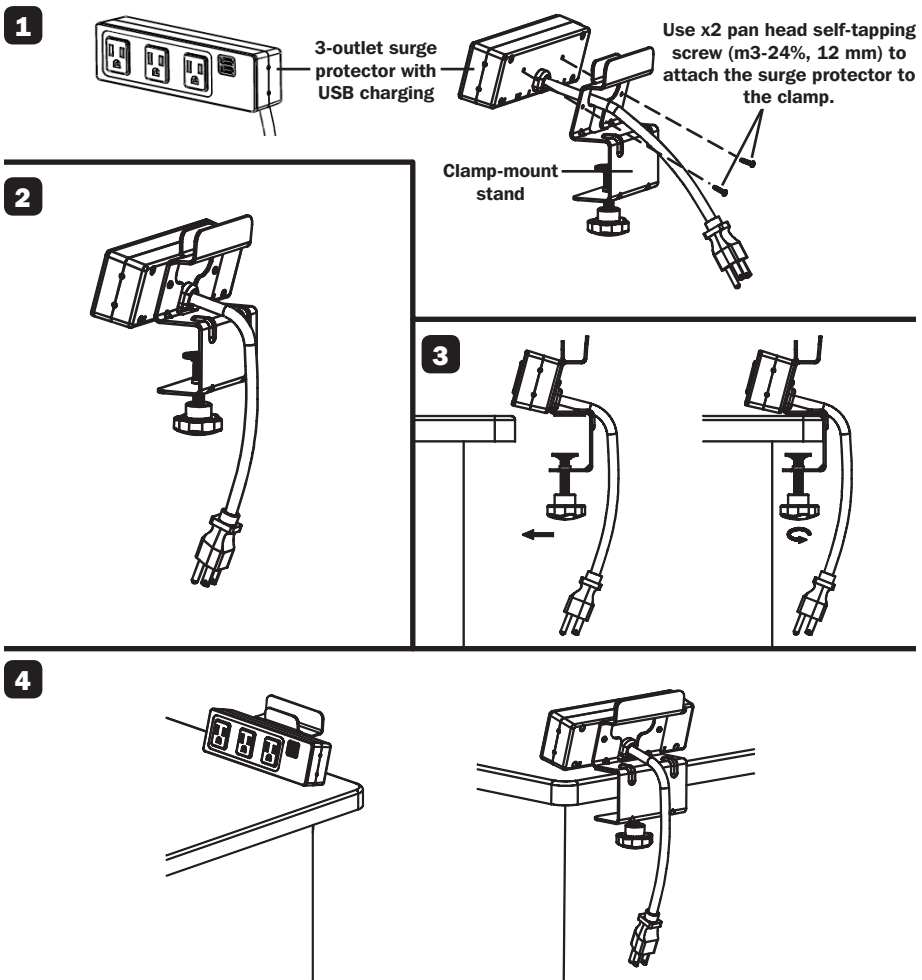

Installation –TLP310USBS Mounting Brackets Model



IMPORTANT!

This unit contains two mounting hardware bags.

Use the bag as listed for the appropriate mounting installation:

Bag A – In-Desk Mounting

x2 Mounting bracket

x4 Flat head machine screw (6#32T, 1/4")

x2 Truss head self-tapping screw (M4-16T, 14 mm)

Bag B – Under/On Desk Mounting

x2 Mounting bracket

x4 Flat head machine screw (6#32T, 1/4")

x4 Truss head self-tapping screw (M4-16T, 14 mm)

In-Desk Mounting

⚠ Use **Bag A** hardware contents for this installation.

1

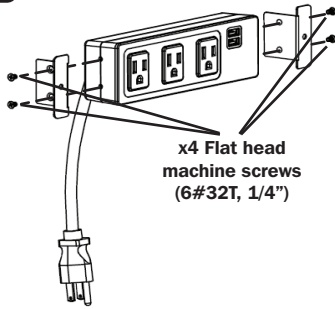

2

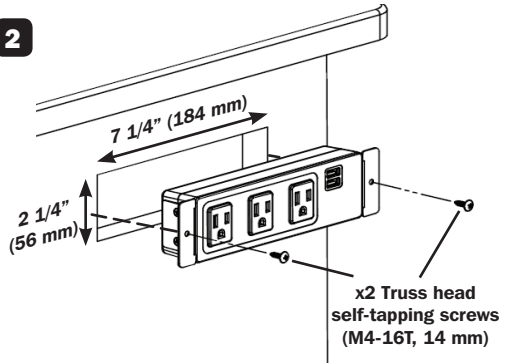

Under/On Desk Mounting

⚠ Use **Bag B** hardware contents for this installation.

Under Desk

1

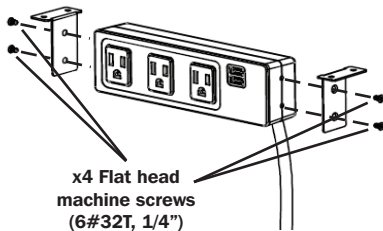

2

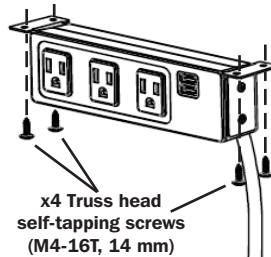

or On Desk

1

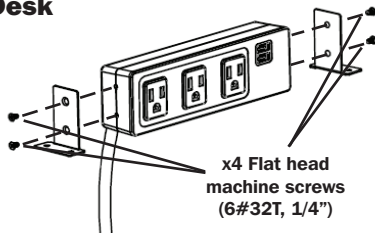

2

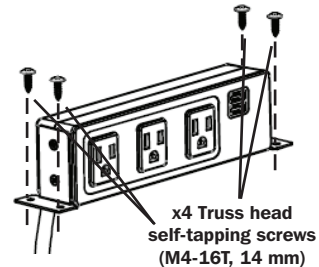

Product Registration

Visit www.tripplite.com/warranty today to register the warranty for your new Tripp Lite product. You'll be automatically entered into a drawing for a chance to win a FREE Tripp Lite product!*

* No purchase necessary. Void where prohibited. Some restrictions apply. See website for details.

Lifetime Limited Warranty

Seller warrants this product, if used in accordance with all applicable instructions, to be free from original defects in material and workmanship for its lifetime. If the product should prove defective in material or workmanship within that period, Seller will repair or replace the product, in its sole discretion. Service under this Warranty can only be obtained by your delivering or shipping the product (with all shipping or delivery charges prepaid) to: Tripp Lite, 1111 W. 35th St., Chicago, IL 60609. Seller will pay return shipping charges.

The warranties of all TRIPP LITE surge suppressors are null and void if they have been connected to the output of any UPS system. The warranties of all TRIPP LITE UPS Systems are null and void if a surge suppressor has been connected to its output receptacles.

THIS WARRANTY DOES NOT APPLY TO NORMAL WEAR OR TO DAMAGE RESULTING FROM ACCIDENT, MISUSE, ABUSE OR NEGLIGENCE. SELLER MAKES NO EXPRESS WARRANTIES OTHER THAN THE WARRANTY EXPRESSLY SET FORTH HEREIN. EXCEPT TO THE EXTENT PROHIBITED BY APPLICABLE LAW, ALL IMPLIED WARRANTIES, INCLUDING ALL WARRANTIES OF MERCHANTABILITY OR FITNESS, ARE LIMITED IN DURATION TO THE WARRANTY PERIOD SET FORTH ABOVE; AND THIS WARRANTY EXPRESSLY EXCLUDES ALL INCIDENTAL AND CONSEQUENTIAL DAMAGES. (Some states do not allow limitations on how long an implied warranty lasts, and some states do not allow the exclusion or limitation of incidental or consequential damages, so the above limitations or exclusions may not apply to you. This Warranty gives you specific legal rights, and you may have other rights which vary from jurisdiction to jurisdiction.)

WARNING: The individual user should take care to determine prior to use whether this device is suitable, adequate or safe for the use intended. Since individual applications are subject to great variation, the manufacturer makes no representation or warranty as to the suitability or fitness of these devices for any specific application.

The policy of Tripp Lite is one of continuous improvement. Specifications are subject to change without notice.

Regulatory Compliance Identification Numbers

For the purpose of regulatory compliance certifications and identification, your Tripp Lite product has been assigned a unique series number. The series number can be found on the product nameplate label, along with all required approval markings and information. When requesting compliance information for this product, always refer to the series number. The series number should not be confused with the marketing name or model number of the product.

Ultimate Lifetime Insurance Policy

This is a limited warranty valid in the U.S. and Canada only.

Tripp Lite warrants, for the lifetime of the product, (at Tripp Lite's option) to repair or replace (on a pro rata basis) directly connected equipment that is damaged due to power transients while properly connected to Tripp Lite products offering the Ultimate Lifetime Insurance Policy. Power transients include spikes and surges on the AC power, data or telephone lines that the Tripp Lite products have been designed to protect against (as recognized by industry standards). The following four paragraphs are conditions that must be complied with before the warranty becomes valid; failure to comply with these requirements will void the warranty.

AC Power Line Transients: To claim damages, the Tripp Lite product must be plugged into a properly wired and grounded outlet. No extension cords or other electrical connections may be used. The installation must comply with all applicable electrical and safety codes set forth by the National Electrical Code (NEC). Except as provided above, this warranty does not cover any damage to properly connected electronic equipment resulting from a cause other than an "AC power transient". If user meets all of the above requirements, Tripp Lite will repair or replace (at Tripp Lite's option) equipment up to the specified value (See Ultimate Lifetime Insurance Policy Limits). No coverage is allowed for damage entering from telephone or data lines, unless they are separately protected, as described below.

Telephone and Data Line Transients: Tripp Lite will repair or replace directly connected equipment that is damaged by transients on telephone and/or data lines only when all such paths are protected by a Tripp Lite protection product(s) and the AC power (utility) line is simultaneously protected by a Tripp Lite power protection device (UPS, surge suppressor or line conditioner) with Ultimate Lifetime Insurance coverage. Additional telephone and/or data line connected devices downstream must have their own telephone and/or dataline protectors.

Reimbursement dollar limits will be equal to that of the Tripp Lite power protection protector. Coverage is excluded where a suitable environment for the protection device is not provided, including, but not limited to, lack of a proper safety ground. Telephone service equipment must also include a properly installed and operating "primary protection" device at the telephone service entrance (such devices are normally added during telephone line installation).

All above warranties are null and void if the Tripp Lite product has been improperly installed, tampered with or altered in any way, or if the connected equipment was not used under normal operating conditions or in accordance with any labels or instructions. All claims under this warranty must be submitted in writing to Tripp Lite within 30 days of the occurrence or the claim will not be considered. This warranty does not include damage resulting from accident or misuse, and applies to the domestic (USA & Canada) use of these products only. Tripp Lite reserves the right to determine whether the damage to the connected equipment is due to malfunction of the Tripp Lite product by requesting the equipment in question be sent to Tripp Lite for examination. This policy is above and beyond, only to the extent needed, of that provided by any coverage of connected equipment provided by other sources, including, but not limited to, any manufacturer's warranty and/or any extended warranties.

EXCEPT AS PROVIDED ABOVE, TRIPP LITE MAKES NO WARRANTIES, EXPRESS OR IMPLIED, INCLUDING WARRANTIES OF MERCHANTABILITY AND FITNESS FOR A PARTICULAR PURPOSE. Some states do not permit limitation or exclusion of implied warranties; therefore, the aforesaid limitation(s) or exclusion(s) may not apply to purchaser. EXCEPT AS PROVIDED ABOVE, IN NO EVENT WILL TRIPP LITE BE LIABLE FOR DIRECT, INDIRECT, SPECIAL, INCIDENTAL OR CONSEQUENTIAL DAMAGES ARISING OUT OF THE USE OF THIS PRODUCT, EVEN IF ADVISED OF THE POSSIBILITY OF SUCH DAMAGE. Specifically, Tripp Lite is not liable for any costs, such as lost profits or revenue, loss of equipment, loss of use of equipment, loss of software, loss of data, costs of substitutes, claims by third parties or otherwise. Coverage also does not apply to connected medical and industrial equipment.

To receive service under this warranty, you must be the original purchaser/user of the product in question. You must obtain a Returned Material Authorization (RMA) number from Tripp Lite. Products must be returned to Tripp Lite with transportation charges prepaid and must be accompanied by a brief description of the problem encountered and proof of date and place of purchase



1111 W. 35th Street, Chicago, IL 60609 USA • www.tripplite.com/support