

Installation Guide

Link Span Kit for Wire Basket Cable Trays

Models:

SRWBARCBFFL, SRWBARCBFFL4

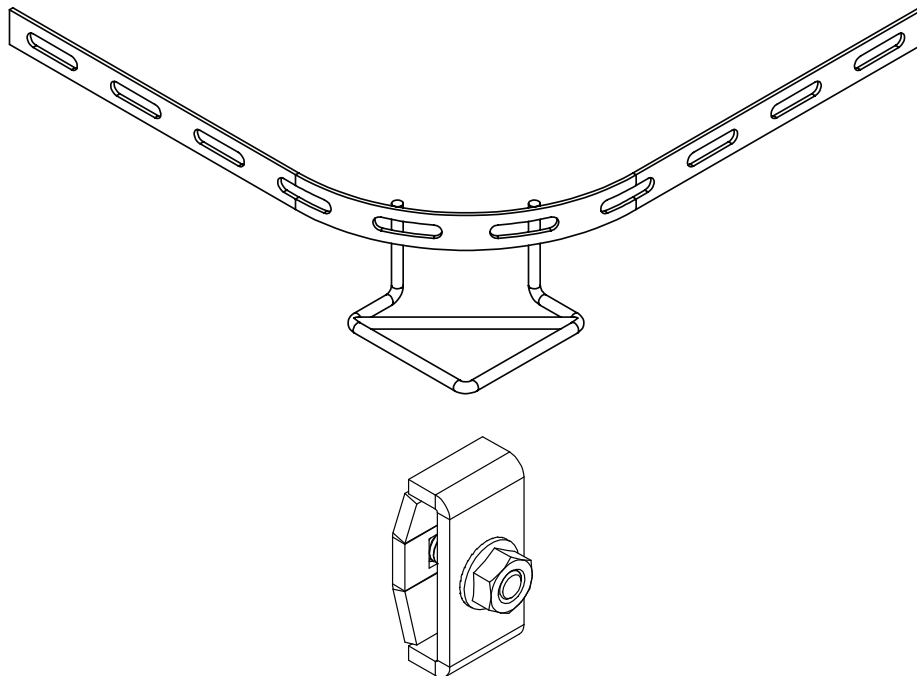

Este guía esta disponible en español
en la página de Tripp Lite:
www.tripplite.com/support

Ce guide est disponible en français
sur le site Web de Tripp Lite :
www.tripplite.com/support

Русскоязычная версия настоящего
краткого руководства представлена
на веб-сайте компании Tripp Lite по
адресу: www.tripplite.com/support

TRIPP·LITE



1111 W. 35th Street, Chicago, IL 60609 USA • www.tripplite.com/support

Copyright © 2019 Tripp Lite. All rights reserved.

Parts List

1 x

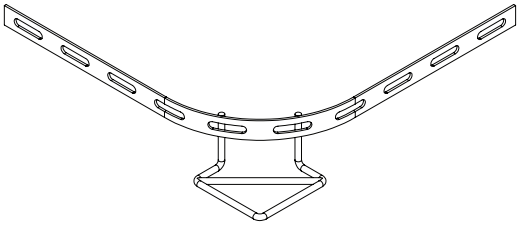

SRWBARCBFFL or **SRWBARCBFFL4**
 (For use with 2" tall wire baskets) (For use with 4" tall wire baskets)

4 x

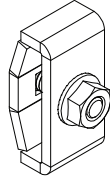

SRWBUNVCPLR
 Coupler

Wire Tray Configuration



For instructions on cutting and fabricating wire basket trays, please refer to the documentation included with the SRWB Wire Baskets (sold separately).

This section provides wire tray cutting patterns and configuration instructions. For the sectional views shown for each wire tray model, the wires in the red portions should be cut and wires in the black portions should remain intact (see example below).



Assembly

90° Bends

6" (150 mm) Wire Basket Model(s): SRWB6210STR, SRWB6410STR

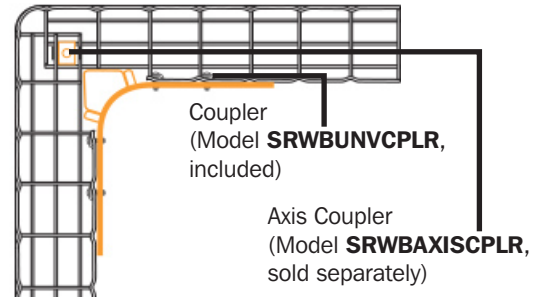
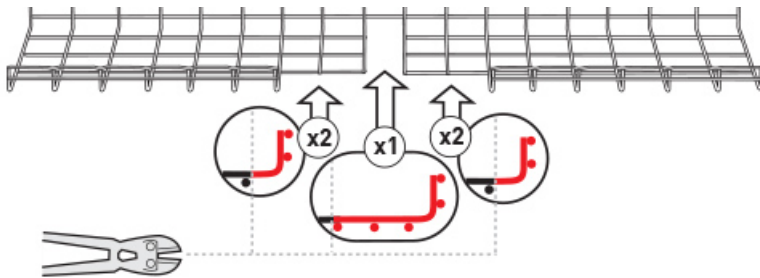

12" (300 mm) Wire Basket Model(s): SRWB12210STR, SRWB12410STR

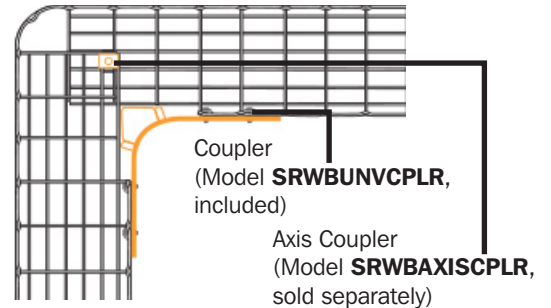
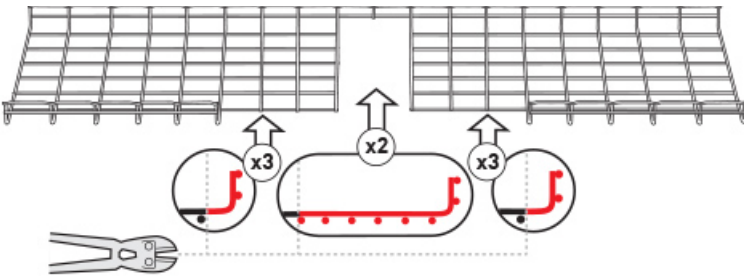

18" (457 mm) Model: SRWB18410STR

